

# KOMPEN

PVC KAPI PENCERE SİSTEMLERİ



## Ürün Katalođu

Product Catalogue  
Каталог Товаров

كتالوج المنتجات



# **HYPERLINE**

**Contalı Sızdırmaz Sürme Seri**

Innovative Sliding Series / Раздвижная система / للسحاب ختم بجوان

### Kom 1801 / ١٨.١ كوم

Contalı Sürme Kasa Profili	Ağırlık : 2200 gr/mt
Sliding Frame Profile	Weight : 2200 gr/mt
Раздвижная Рама	Bec : 2200 гр/м
بروفیل الإطار للسحاب بجوان	الوزن : ٢٢٠٠ غ / م

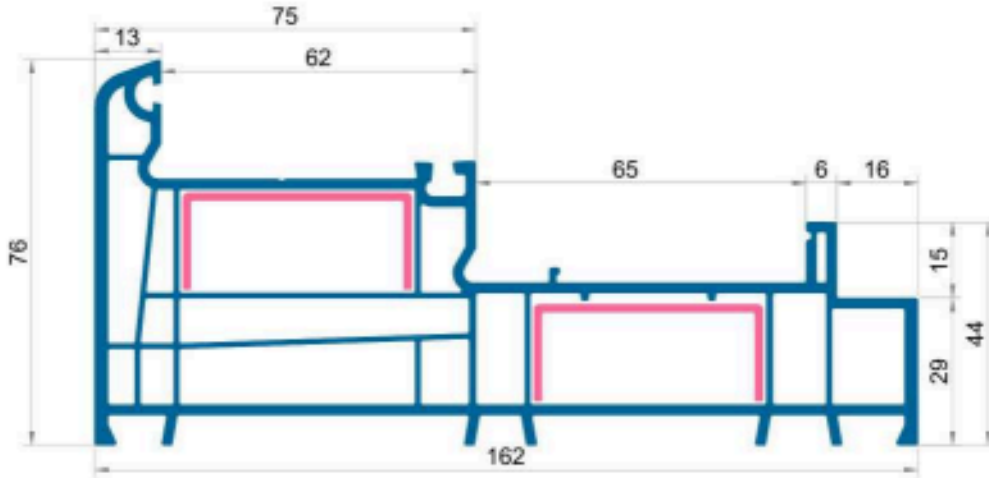

### Kom 1804 / ١٨.٤ كوم

Contalı Sürme Kanat Profili	Ağırlık : 1570 gr/mt
Sliding Sash Profile	Weight : 1570 gr/mt
Створка Раздвижной	Bec : 1570 гр/м
بروفیل ضلفة للسحاب بجوان	الوزن : ١٥٧٠ غ / م

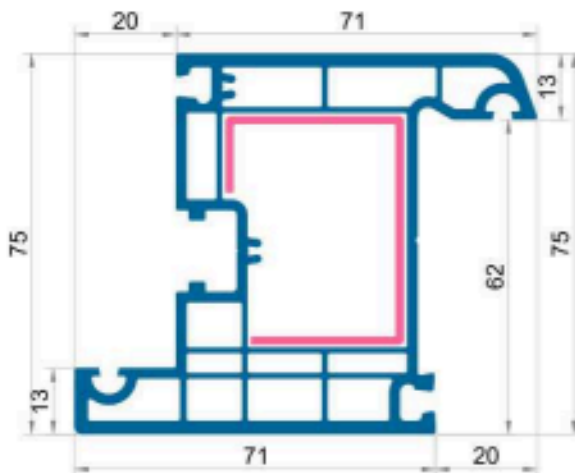

### Kom 1803 / ١٨.٣ كوم

Contalı Sürme Ortakayıt Profili	Ağırlık : 1325 gr/mt
Sliding Mullion Profile	Weight : 1325 gr/mt
Импост Раздвижной	Bec : 1325 гр/м
بروفیل تی للسحاب بجوان	الوزن : ١٣٢٥ غ / م

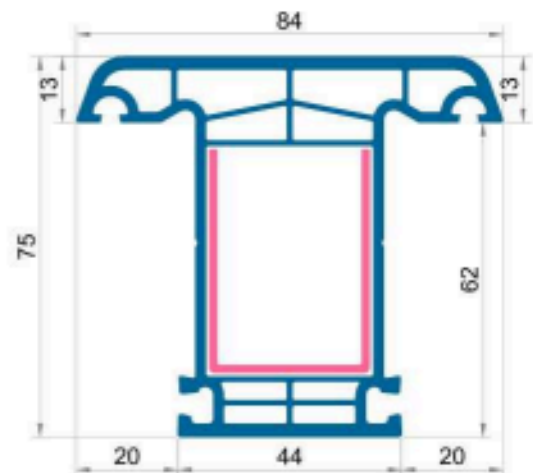

## Kasa - Kanat Uygulaması

Frame - Sash, cross - section / Применение рама-створка / تطبيق الإطار مع الضلعة

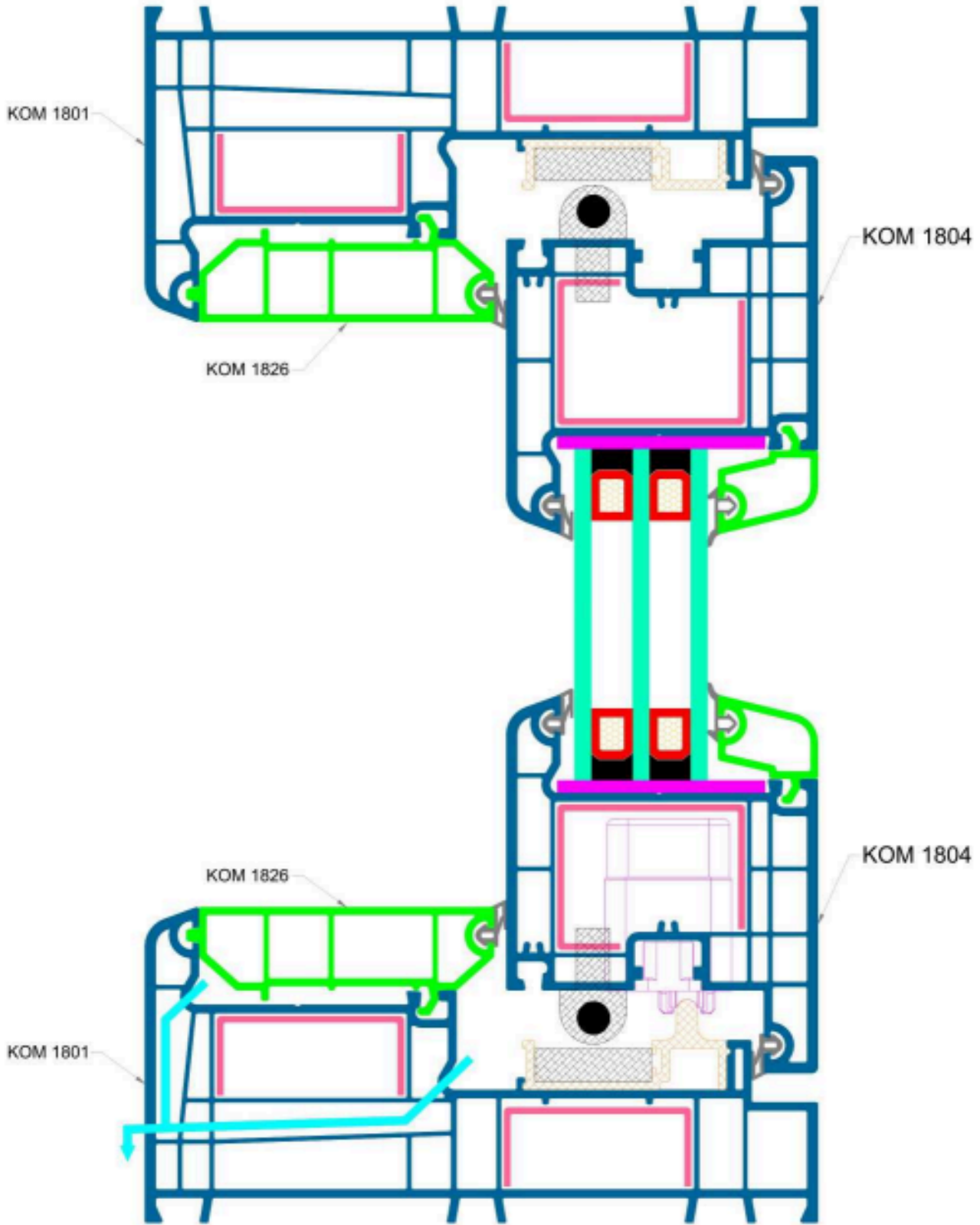

## Kasa - Kanat Uygulaması

Frame - Sash, cross - section / Применение рама-створка / تطبيق الإطار مع الضلعة

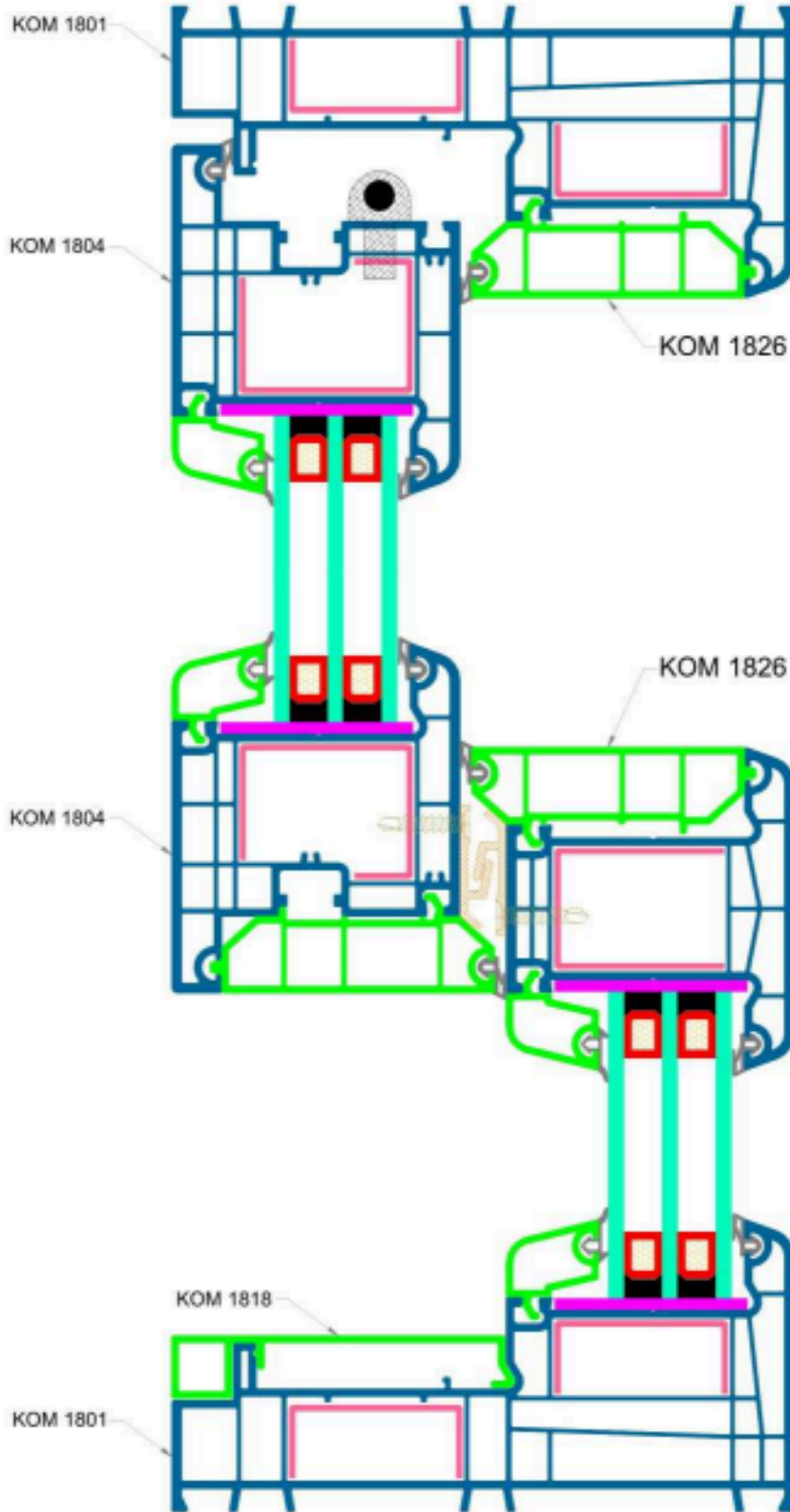

## Çıtalar - Glazing Beads - Штапики - مثبت الزجاج

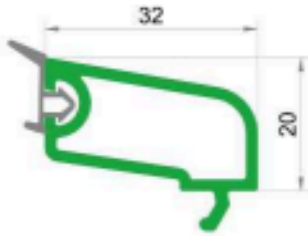

### Kom 1808 / ١٨٠٨ كوم

24 mm. Çift Cam Çıtası	Ağırlık : 260 gr/m.
Double Glazing bead for 24mm.	Weight : 260 gr/m.
Штапик 24 мм стеклопакета	Вес : 260 гр/м
مثبت الزجاج للزجاج المزدوج ٢٤ ملم	الوزن : ٢٦٠ غ / م

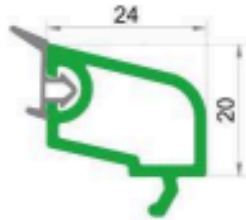

### Kom 1809 / ١٨٠٩ كوم

32 mm. Cam Çıtası	Ağırlık : 220 gr/mt
Double Glazing bead for 32 mm.	Weight : 220 gr/mt
Штапик 32 мм стеклопакета	Вес : 220 гр/м
مثبت الزجاج للزجاج المزدوج ٣٢ ملم	الوزن : ٢٢٠ غ / م

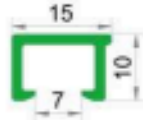

### Kom 1810 / ١٨١٠ كوم

Denge Çıtası	Ağırlık : 76 gr/mt
Adjustment Bead	Weight : 76 gr/mt
Штапик	Вес : 76 гр/м
شريط التوازن	الوزن : ٧٦ غ / م



## Destek Sacı - Reinforcement profile - Усилитель - حديد التسليح

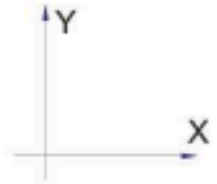

KOM  
1801



Kalınlık Thickness	Ağırlık Weight	I <sub>x</sub>	I <sub>y</sub>
1.20 mm	1044 g/m	0.94 cm <sup>4</sup>	3.64 cm <sup>4</sup>
1.50 mm	1296 g/m	1.13 cm <sup>4</sup>	4.44 cm <sup>4</sup>
2.00 mm	1700 g/m	1.41 cm <sup>4</sup>	5.68 cm <sup>4</sup>

KOM  
1801

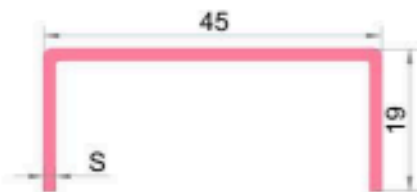

Kalınlık Thickness	Ağırlık Weight	I <sub>x</sub>	I <sub>y</sub>
1.20 mm	690 g/m	0.33 cm <sup>4</sup>	2.94 cm <sup>4</sup>
1.50 mm	856 g/m	0.40 cm <sup>4</sup>	3.60 cm <sup>4</sup>
2.00 mm	1130 g/m	0.51 cm <sup>4</sup>	4.64 cm <sup>4</sup>

KOM  
1804

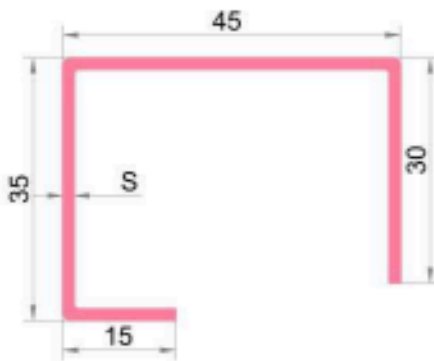

Kalınlık Thickness	Ağırlık Weight	I <sub>x</sub>	I <sub>y</sub>
1.20 mm	1044 g/m	2.33 cm <sup>4</sup>	4.76 cm <sup>4</sup>
1.50 mm	1296 g/m	2.84 cm <sup>4</sup>	5.84 cm <sup>4</sup>
2.00 mm	1700 g/m	3.64 cm <sup>4</sup>	7.54 cm <sup>4</sup>

KOM  
1803

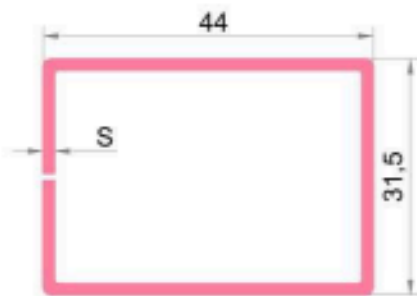

Kalınlık Thickness	Ağırlık Weight	I <sub>x</sub>	I <sub>y</sub>
1.20 mm	1245 g/m	2.90 cm <sup>4</sup>	4.81 cm <sup>4</sup>
1.50 mm	1548 g/m	3.53 cm <sup>4</sup>	5.89 cm <sup>4</sup>
2.00 mm	2037 g/m	4.51 cm <sup>4</sup>	7.57 cm <sup>4</sup>

KOM  
822

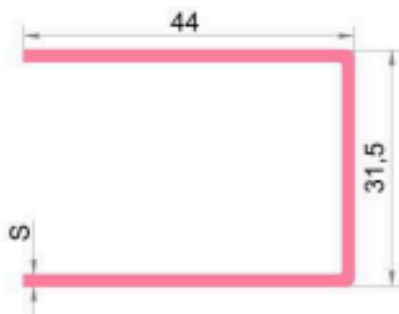

Kalınlık Thickness	Ağırlık Weight	I <sub>x</sub>	I <sub>y</sub>
1.20 mm	1010 g/m	2.66 cm <sup>4</sup>	2.89 cm <sup>4</sup>
1.50 mm	1252 g/m	3.25 cm <sup>4</sup>	3.57 cm <sup>4</sup>
2.00 mm	1656 g/m	4.17 cm <sup>4</sup>	4.67 cm <sup>4</sup>